

DOI: <https://doi.org/10.15276/aait.05.2022.3>

UDC 621.33:629.3.027.2

Lateral stability control system for front two-wheel independent driving electric vehicle

Ihor Z. ShchurORCID: <https://orcid.org/0000-0001-7346-1463>; ihor.z.shchur@lpnu.ua. Scopus Author ID: 36348908300
Lviv Polytechnic National University. 12, S. Bandery Str. Lviv, 79013, Ukraine

ABSTRACT

High specific indicators of power and torque of modern electric motors, as well as the relative ease of implementation of electric drive system, determines the feasibility of using in electric vehicles independent drives for two or more wheels. The configuration of pure electric vehicles with two driving front wheels, which is considered in this paper, is still uncommon, but it has the advantage of a radical simplification of transmission and steering mechanism. A specific feature of this configuration is the ability to perform by front-wheel drive systems, in addition to the main function of traction and braking by the low-level of control, a number of additional functions at the high-level of control. In addition to the previously developed functions of the electronic differential, electric strengthening of steering and damping of spring oscillations of the steering mechanism, this paper also adds the function of lateral vehicle stability control in electric vehicles cornering. The article considers a seven-degree of freedom mathematical model of dynamics of a four-wheeled vehicle and shows how this model can be simplified to a two-degree of freedom model describing the dynamics of an two-wheeled vehicle. This model is sufficient to assess the lateral stability of electric vehicles in cornering and for formation the reference of additional yaw-moment, which would regulate the yaw-rate to prevent the electric vehicles skidding. On this basis, the structure of the lateral vehicle stability system was developed, which corrects the electromagnetic torques of the drive motors of the front wheels to form the desired yaw-moment. For the studied electric vehicles with the set parameters, the dependences of the allowable yaw-rate on the set by a driver electric vehicles speed and angle of wheels turn in different traction conditions of wheels with a roadway are calculated. A general functional model of a front driving by two independent motors electric vehicles with a two-level control system that performs all the above functions has been developed. In the Matlab/Simulink environment, a computer mathematical model of this electric vehicle was built and simulation studies were conducted, which demonstrate the operation of the proposed lateral vehicle stability system.

Keywords: Electric vehicle; front two-wheel independent drive; in-wheel motor; brushless DC motor; electronic differential; lateral vehicle stability system

For citation: Shchur I. Z. "Lateral stability control for front two-wheel independent driving electric vehicle". *Applied Aspects of Information Technology*. 2022; Vol. 5 No. 1: 35–46. DOI: <https://doi.org/10.15276/aait.05.2022.3>

INTRODUCTION

Unlike a car, drivetrain subsystems of electric vehicles (EV) can have different configurations, which opens up new opportunities to improve the quality of control, reliability of the EV mechanical part and its simplification. In particular, interesting, but still little studied, is the configuration of front-driving EV with two independent wheel motors or in-wheel motors, which simplifies the transmission and steering systems and thus significantly increases the reliability of the EV and reduce its cost [1]. In addition to a gearbox and clutch, this configuration also does not include a mechanical differential, the functions of which are performed by an electronic differential. Due to the control of electromagnetic torques of the wheel motors, as well as their speeds, you can not only effectively ensure the cornering of the EV, but also perform other functions, such as power steering, damping of spring oscillations in mechanical connections of the steering mechanism, EV stabilization in cornering [2, 3].

LITERATURE REVIEW

In a front-driving EV with two independent driving wheels, the control system of electric drives has 2-level structure [2, 4]. Low-level controllers provide a high-speed control of the electromagnetic torques of the wheel motors, and a high-level one performs additional control functions – formation the references for the low-level controllers. The first main function is to control the speed of movement, i.e. to adjust the references for the electromagnetic torques of the wheel motors in accordance with the position of an accelerator set by a driver. The second function should ensure the equality of the electromagnetic torques of the motors regardless of the angular velocity of the wheels in cornering, i.e. an electronic differential replaces the traditional mechanical one. In addition, it is advisable and quite realistic to put on the high-level control system the third function – strengthening of the steering in the EV cornering, which allows you to get rid a complex and powerful car device – hydraulic or electric power steering. In the front 2-wheel independent

© Shchur, I. 2022

This is an open access article under the CC BY license (<http://creativecommons.org/licenses/by/4.0/deed.uk>)

driving EV, the latter function is called “power steering control” [5]. In our works [6, 7], the second function of the high-level control system of two electric drives of the front wheels is implemented based on the Ackermann-Jeantaud steering geometry. The third function of this system, which also provides the damping of spring oscillations of the steering mechanism, is implemented based on of the approach described in [5].

In EVs with two or four driving wheels, it is advisable to put on the high-level control system additionally one more function – to ensure a lateral vehicle stability (LVS) in EV cornering. High-speed and accurate control of the electromagnetic torques of drive motors, which can providing by modern control systems, allows to achieve much better efficiency of the LVS system compared to similar work of such systems in cars, where they are implemented through their braking systems. To date, a lot of research has been done on the development of LVS systems for EVs, but they usually concern the EVs with two rear-wheel independent drives [2, 4] or all-wheel drive EVs with four independent drives [8, 9].

THE PURPOSE OF THE ARTICLE

This paper shows how we can develop our already created in [6, 7] control system for the front 2-wheel independent driving EV in the direction of providing the LVS function, namely to ensure the control of the EV yaw-rate to prevent lateral sliding of its wheels in cornering.

MAIN PART. MATHEMATICAL MODELING OF EV DYNAMICS

Dynamics of EV body with wheels

Currently, many mathematical models have been developed that describe the movement of the EV body with four wheels [2, 3], [4]. They differ in the degree of detail of description and, accordingly, the number of degree of freedom (DOF), which is taken into account when describing the EV dynamics. Their number ranges from 2 to 14. However, the most common is the 7-DOF model of body movement, which is quite accurate.

The 7-DOF model of EV body motion includes the equation of force balances according to the Newton's second law with respect to the longitudinal x and lateral y axes of body motion, its rotational motion relative to the vertical z axis, and the rotational motion of each wheel. Deviations of the body from the vertical axis (roll) in this model are not taken into account. Fig. 1 shows in the x - y plane

the kinematic diagram of a 4-wheeled EV with the designation of the forces acting on each of its wheels during the skidding of the EV in the turn. Under the action of these forces, the linear velocities of the front and rear wheels v_{ij} have directions that deviate from the longitudinal axes of the wheels at angles α_{ij} . The linear velocity of the center of mass of the EV body v also deviates from the longitudinal axis of the body by the angle of lateral sliding β (side slip angle) causing the rotation of the body relative to the vertical axis z passing through its center of mass with angular velocity γ . This movement of the body is called yaw.

Using the kinematic diagram of 4-wheel EV (Fig. 1), the mathematical 7-DOF model of its dynamics can be represented by the following equations [3, 4]:

– longitudinal movement of the body (relative to the x axis)

$$m(v_x' + v_x \gamma) = (F_{xfr} + F_{xfl}) \cos \delta - (F_{yfr} + F_{yfl}) \sin \delta + F_{xrl} + F_{xrr}; \quad (1)$$

– lateral movement of the body (relative to the y axis)

$$m(v_y' + v_y \gamma) = (F_{yfl} + F_{yfr}) \cos \delta - (F_{xfr} + F_{xfl}) \sin \delta + F_{yrl} + F_{yrr}; \quad (2)$$

– rotational movement of the body - yaw (rotational movement relative to the z axis)

$$J_z \dot{\gamma} = a(F_{yfl} + F_{yfr}) \cos \delta + 0.5d(F_{yfl} - F_{yfr}) \sin \delta - b(F_{yrl} + F_{yrr}) + 0.5d(F_{xfr} + F_{xfl}) \cos \delta + a(F_{xfl} + F_{xfr}) \sin \delta + 0.5d(F_{xrr} + F_{xrl}); \quad (3)$$

– rotational movement of each of the four wheels

$$J_w \dot{\omega}_{ij} = M_{dij} - M_{bij} - F_{xij} r_w. \quad (4)$$

In equations (1)-(4) it is denoted (see Fig. 1): m is the equipped EV mass, v_x and v_y are the longitudinal and lateral speeds of the EV body, F_{xij} and F_{yij} are the components of forces acting on the EV body from the wheels ($i = f, r$ – front, rear, $j = l, r$ – left, right wheels) along the x and y axes, δ is the angle of turn of the front EV wheels, a and b are the sections from the center of mass to the front and rear axes of the EV, d is the distance between the left and right wheels, J_z is the moment of inertia of the body relative to the vertical axis z passing through the center of EV mass, J_w is the moment of inertia of the wheel, ω_{ij} are the angular velocities of the wheels, T_{dij} are the driving torques of wheels, T_{bij} are the braking torques of driving wheels, and r_w is the radius of rolling of the wheel.

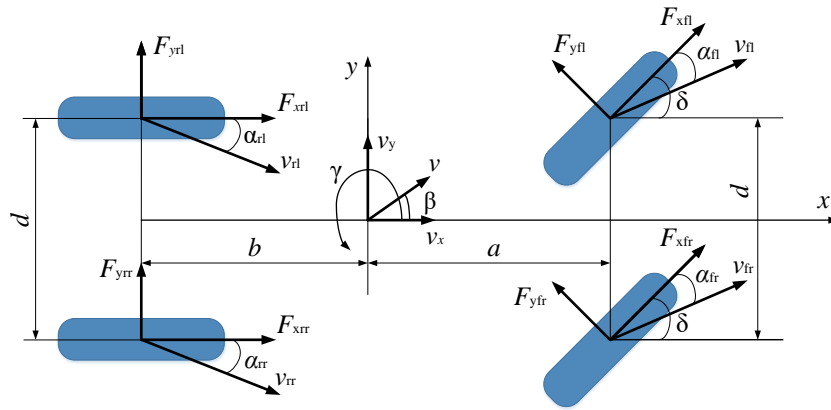

Fig. 1. Kinematic diagram of 4-wheeled vehicle in x-y reference frame

Source: [3]

Tire dynamics in a turn

The movement of the EV body depends on the forces generated by the wheels and the linkage of the wheels with the road surface. These factors allow you to change the direction and speed of the vehicle. The longitudinal and lateral forces are created by each wheel due to the deformation of its tire at the point where it interacts with the road during acceleration, braking and cornering. Due to nonlinear relationships between variables, wheels are the most complex element for mathematical modeling [10].

In the absence of lateral force, the wheel moves directly along its plane. However, when maneuvering in cornering, the area of direct contact of the wheel slides sideways, creating the lateral force F_y acting on the wheel. The angle between the direction of motion and the plane of the wheel is called the sliding angle of the wheel α . Because the resulting force acts slightly behind the center of the wheel (pneumatic track), it generates torque that aligns the wheel in the direction of travel. Normal maneuvering in turns occurs at small sliding angles, low lateral force and minimal wheel slip. At large sliding angles, the lateral force increases and reaches a maximum, then the wheel begins to slide. Beyond this point, the lateral force decreases but continues to maintain a relatively constant value. For small values of α , less than about four degrees, the ratio of lateral force to sliding angle is almost constant and is characterized by the tire stiffness in rotation C . As the sliding angle increases, the maximum alignment torque decreases because the pneumatic track decreases.

There are several wheel models that describe the full range of wheel behavior outside the linear domain. The Pacejka model is commonly used in studies of car dynamics [4, 10], [11]. This wheel model provides a method for calculating the longitudinal, lateral forces of the wheels and the

equalizing torque for a wide range of vehicle operating conditions. This model is also called the “Magic Tire Formula” because it is based on experimental data. The Pacejka model is a special function obtained in accordance with experimentally measured data on wheel behavior. Each function has eight coefficients, the value of which depends on the type and characteristics of the tires, and four parameters such as stiffness, shape, maximum and curvature factors, which, in turn, are variables of the vertical pressure force on the wheel.

Dynamics of the wheel drive

To develop an EV motion stabilization system, the wheel drive model can be simplified. Since modern AC drives used in EV, asynchronous and synchronous, are built on the vector principle, their work is closer to the drive system based on a DC motor [12]. For such a motor, the relationship between the electromagnetic torque and its input voltage can be represented by a known dependence

$$T_a = \frac{(K_M/R_a)}{1+(L_a/R_a)s} u_a \tag{5}$$

where: K_M is the motor constant; R_a is the resistance of the armature winding; L_a is the inductance of the armature winding and u_a is the armature voltage.

The relationship between the motor torque T and the longitudinal force F_x of the wheel is

$$F_x = \frac{T i}{R_w}, \tag{6}$$

where i is the gear ratio (if any).

LATERAL EV STABILITY CONTROL SYSTEM

Construction of the master model

The main task of the LVS system is to generate the desired values of the yaw-rate and the side slip

angle depending on the angle of turn of the front wheels and the speed of the EV [3, 4], [9]. To simplify the determination of the desired values of these variables, we make the following assumptions: the forces acting on the side of the EV wheels are described by linear dependences on the amount of slip, the longitudinal speed of the vehicle is constant, and the angle of lateral deviation of the wheel from its longitudinal axis α is small. Under these assumptions, the 7-DOF model of a 4-wheeled vehicle can be reduced to its 2-DOF model, as shown in Fig. 2 [2, 4].

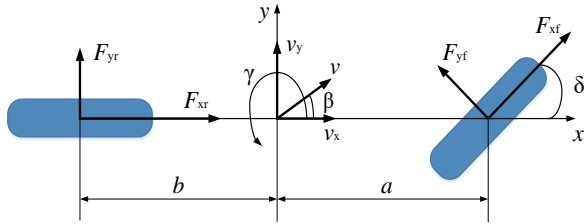

Fig. 2. Kinematic diagram of 2-wheeled vehicle in x-y reference frame
Source: [3, 4]

For the 2-wheeled EV model instead of (1)-(3) we can write the following equations:

$$m(v_x' + v_y\gamma) = F_{xf} \cos\delta - F_{yf} \sin\delta + F_{xr}; \quad (7)$$

$$m(v_y' + v_x\gamma) = F_{yf} \cos\delta - F_{xf} \sin\delta + F_{yr}; \quad (8)$$

$$J_z\dot{\gamma} = a(F_{xf} \sin\delta + F_{yf} \cos\delta) - bF_{yr}. \quad (9)$$

If the turn angle of the front wheels δ is small, we can assume that $\cos\delta \cong 1$ and $\sin\delta \cong 0$, and equations (7)-(9) are reduced to the following form:

$$m(v_x' + v_y\gamma) = F_{xf} + F_{xr}; \quad (10)$$

$$m(v_y' + v_x\gamma) = F_{yf} + F_{yr}; \quad (11)$$

$$J_z\dot{\gamma} = aF_{yf} - bF_{yr}. \quad (12)$$

The term $v_y\gamma$ in the first equation is the product of two small variables, so it can be neglected. Then equation (10) is reduced to the form

$$mv_x' = F_{xf} + F_{xr}. \quad (13)$$

Equation (13) is not related to other two equations (11) and (12) and can be used to study the acceleration of EV in linear motion.

If we consider the speed of vehicle v_x as one of the DOF, the resulting system of equations (11)-(12) is reduced to finding the lateral speed v_y and the yaw-rate γ .

Knowing that under normal driving conditions the sliding angles are usually less than four degrees, the 2-wheeled model allows you to express the lateral forces acting on the EV wheels during the cornering in a linear manner:

$$F_{yf} = -2C_f \alpha_f; \quad F_{yr} = -2C_r \alpha_r, \quad (14)$$

where C_f, C_r are the angular stiffness of the tires of the front and rear axles during cornering.

Substituting expressions (14) in equations (11)–(12), we obtain:

$$m(v_y' + v_x\gamma) = -2C_f \alpha_f - 2C_r \alpha_r, \quad (15)$$

$$J_z\dot{\gamma} = -2aC_f \alpha_f + 2bC_r \alpha_r. \quad (16)$$

The values of the sliding angles can be written from the 2-wheeled model as follows:

$$\alpha_f = \delta - \arctan\left(\frac{v_y + a\gamma}{v_x}\right) \cong \delta - \frac{v_y + a\gamma}{v_x}; \quad (17)$$

$$\alpha_r = -\arctan\left(\frac{v_y - b\gamma}{v_x}\right) \cong -\frac{v_y - b\gamma}{v_x}. \quad (18)$$

Substituting (17) and (18) in equations (15) and (16), we obtain:

$$\begin{bmatrix} v_y' \\ \dot{\gamma} \end{bmatrix} = \begin{bmatrix} \frac{2(C_f + C_r)}{mv_x} & \frac{2(aC_f - bC_r)}{mv_x} \\ \frac{2(aC_f - bC_r)}{I_z v_x} & \frac{2(a^2C_f + b^2C_r)}{I_z v_x} \end{bmatrix} \begin{bmatrix} v_y \\ \gamma \end{bmatrix} + \begin{bmatrix} -2C_f \\ -2aC_f \end{bmatrix} \delta. \quad (19)$$

The side slip angle of the vehicle β is defined as the angle between the longitudinal axis of the vehicle and the velocity vector in the center of EV mass:

$$\beta = \arctan(v_y/v_x). \quad (20)$$

From the linear system of equations (19) we can obtain the transfer function between the yaw-rate γ and the angle of front wheel turn δ [12]:

$$\gamma(s) = \frac{\left(-\frac{amv_x^2}{2LC_f} s + v_x\right) \delta(s)}{\frac{mI_z v_x^2}{4LC_f C_r} s^2 - \frac{(C_f + C_r)I_z v_x + mv_x(a^2C_f + b^2C_r)}{2LC_f C_r} s + \frac{mv_x^2}{2LC_f C_r} (aC_f - bC_r) + 1}, \quad (21)$$

where $L = a + b$ is the EV wheelbase.

The stability of the system described by the transfer function (21) depends on the coefficients of the characteristic polynomial; in particular, the third term should not be negative:

$$\frac{mv_x^2}{2LC_f C_r} (aC_f - bC_r) + 1 > 0 . \quad (22)$$

Analyzing condition (22), we can draw the following conclusions:

- 1) if $aC_f > bC_r$, or $|aC_f| < |bC_r|$, then the cornering angle is not large enough, and the vehicle remains stable;
- 2) if $aC_f = bC_r$, then the vehicle is in neutral and also remains stable;
- 3) if $aC_f < bC_r$, or $|aC_f| > |bC_r|$, then under such conditions there is a skidding on the turn, and the vehicle loses its stability.

Based on condition 2, you can calculate the desired yaw-rate depending on the angle of turn of the front wheels [14, 15]:

$$\gamma_d = \frac{v_x}{L(1 + K v_x^2)} \delta, \quad (23)$$

where $K = \frac{m(bC_r - aC_f)}{2C_r C_r L^2}$.

The lateral acceleration of the vehicle can be written as

$$a_y = \frac{v_x^2}{R_c} = \frac{v_x}{R_c} v_x = \gamma v_x, \quad (24)$$

where R_c is the radius of cornering trajectory.

Since the lateral force cannot exceed the total coupling force between the wheel and the road surface, $m|a_y| \leq mg\mu$, where μ is the relative coefficient of friction between them, then $|a_y| \leq g\mu$. Substituting this constraint in (24), we obtain: $|\gamma| \leq g\mu/v_x$. From here, entering a 15 % margin, you can get the upper limit of the yaw-rate in the form of [3]

$$\gamma_{max} = \frac{0.85g\mu}{v_x}. \quad (25)$$

However, compliance with the desired yaw-rate should not be carried out at any cost, as the second purpose of the LVS system is to limit the side slip angle of the vehicle. Thus, the side slip angle is another indicator of the EV stability. During normal driving, the side slip angle does not exceed $\pm 2^\circ$. The driver usually loses control of the vehicle at large values of the side slip angle. When the steering wheel rotates, the lateral forces of the wheels create an EV yaw-moment, the magnitude of which also depends on the side slip angle. Therefore, the desired side slip angle is chosen equal to zero: $\beta_d = 0$ [3, 4].

Development of the LVS system structure

From the analysis of the conducted researches, two main structures of LVS systems are known,

which correct the torques of EV wheel motors in turns: the first simpler structure, which controls only the yaw-moment [13, 14]; the second is a more complex structure that controls both the yaw-moment and the side slip angle [3, 4].

As part of the general EV motion control system with two front driving wheels, the LVS system receives information on the current value of the EV yaw-rate γ from a corresponding special solid-state sensor of the angular velocity of the vehicle body. The current value of the side slip angle β can also be measured using, for example, an accelerometer paired with GPS [3]. However, due to the complexity, the current value of the angle β is often calculated using a special observer [3, 4].

Given the available capabilities of computer simulation, this paper considers the first simple structure of the LVS system.

Functional diagram of the front 2-wheel independent drive EV control system with electronic differential and the first structure of the LVS system is shown in Fig. 3 [13]. As can be seen from the diagram, the electronic differential system sets the values of the torques for the right T_r^* and left T_l^*

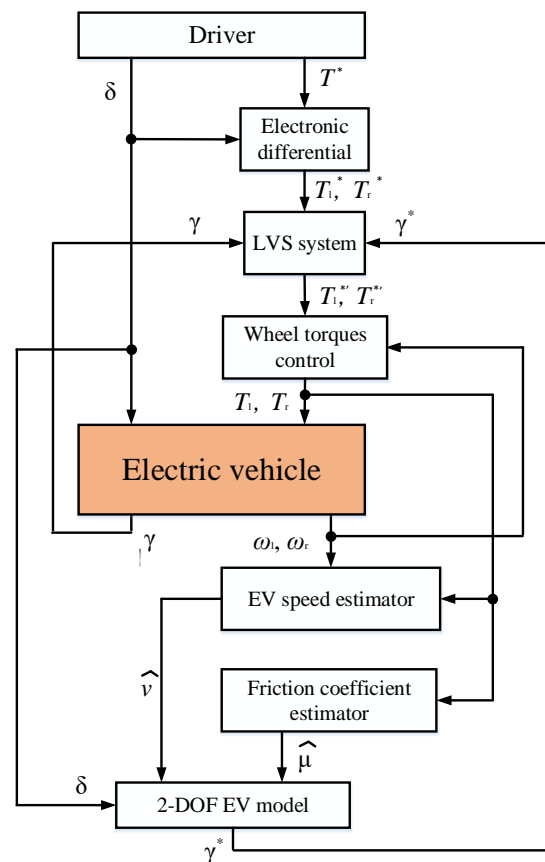

Fig. 3. Functional diagram of the general EV movement control system

Source: [13]

wheels. The LVS system corrects these torque tasks by increasing one and decreasing other on such value ΔT_f to provide the yaw-rate γ , which measured by the appropriate sensor mounted on the EV, on the set value γ^* . Because of this correction, new values of the reference electromagnetic torques of the motors are obtained, respectively for the right $T_r^{*'}$ and left $T_l^{*'}$ wheels. The currently required reference yaw-rate γ^* is calculated according to the 2-DOF driving model according to the driver-specified wheel turn angle δ at the actual EV speed \hat{v} calculated by a speed estimator and the relative coefficient of friction between the wheels and the road surface $\hat{\mu}$, calculated by a corresponding estimator too.

The scheme of realization of this LVS system as the system of the high-level control of EV movement is shown in Fig. 4 by colors. The additional driving or braking torques of the front right and left wheels required to provide the desired yaw-moment T_z and formed at the output of the controller are calculated as follows:

$$\Delta T_{fl} = \frac{2T_z}{d} r_w, \quad \Delta T_{fr} = -\frac{2T_z}{d} r_w. \quad (26)$$

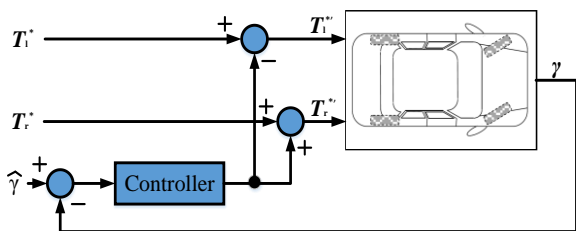

Fig. 4. Scheme of implementation of the LVS system
Source: [13]

Actual driving or braking force is limited by the maximum value of coupling between the wheel and the road surface. The choice of driving or braking torque for the wheel depends on the trajectory of the maneuver and the error of the yaw-rate. For example: in the case of EV cornering to the right, when the actual yaw-rate is greater than its reference value, to maintain the lateral stability, according to (26), ΔT_f must be added to the front right wheel and the same value ΔT_f must be subtracted from the front left wheel. In the process of controlling the LVS, as a rule, the brake system on the rear wheels is involved. For the specified example, at the same time, braking by the rear left wheel is carried out also.

COMPUTER MODELING AND RESEARCH OF EV MOVEMENT CONTROL SYSTEM

Development of functional scheme of the general model of studied EV movement

In the functional scheme of the general model of EV movement (Fig. 5) the driver uses the acceleration and brake pedals to set the total torque of the driving EV wheels T^* , which is evenly distributed between the right and left wheel drives. To make a turning, the driver turns the steering column applying to it the torque T_d . As drives of the right and left wheels, the voltage controlled brushless DC motors with closed-loop by current (torque) control systems are used. The steering control system was developed by us in [6, 7] based on Ackermann-Jeantaud geometry taking into account the springiness of the steering rods. The mathematical model of this system generates the turn angle of the front wheels δ based on the following input values: the torques of the right and left wheels T_r and T_l , their linear speeds v_r and v_l , and the torque applied by the driver to the steering wheel T_d . In real EV, the values of the linear speeds of the wheels are determined by their angular velocities, which are usually measured by appropriate sensors, such as encoders used in control systems for the wheel drives. The change in linear speeds of the wheels in cornering depending on the angle of their turn δ is described by the following expression obtained from the model presented in [6]:

$$\Delta v = v \sin \delta \left\{ \sin^{-1} \left[\arctg \left(\frac{1}{\operatorname{tg} \delta} + \frac{d}{2L} \right)^{-1} \right] - \sin^{-1} \left[\arctg \left(\frac{1}{\operatorname{tg} \delta} - \frac{d}{2L} \right)^{-1} \right] \right\} \quad (27)$$

The high-level control system, which controls the EV movement (EVCS) and includes the control system of the steering mechanism and the LVS system, highlighted in Fig. 5 by dotted frame.

The control system of the steering mechanism, developed by us in [6, 7], ensures the operation of the electronic differential and performs damping of spring oscillations of the steering mechanism. To do this, the output of this system forms a task for the corresponding correction torque ΔT_{r-1} that is added to the reference motor torque of the wheel, which moves over a larger radius of turning, and subtracted from the reference motor torque of the wheel, which moves over a smaller radius of turning.

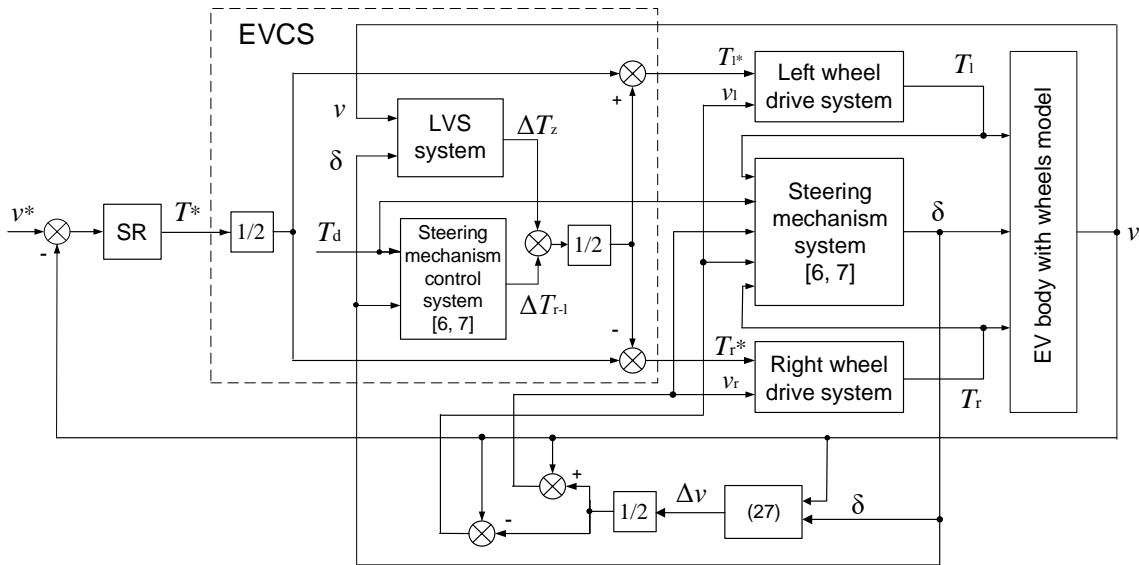

Fig. 5. Functional scheme of the general model of motion of the studied EV

Source: compiled by the author

The LVS system developed in this paper based on the real signals at its input relative to the turn angle of the wheels δ and the EV speed v . This system also forms at its output the task of the corresponding corrective yaw-moment ΔT_z , which acts similarly to the previous one in order to prevent EV drift.

The model of body motion with wheels must correspond to the mathematical 7-DOF model of a 4-wheeled vehicle, which is presented in previous section together with a rather complex empirical mathematical model of wheel behavior. As shown in Fig. 3, according to the results of this model with the help of special sensors or estimators, it is possible to obtain the current values of the EV speed \hat{v} in real road conditions with the friction coefficient of the wheel $\hat{\mu}$. The whole part of the mathematical model is quite complex and its implementation is practically possible only in a specialized computer modeling environment, for example, in the CarSim [15]. Due to the lack of access to such an environment, in this study, the model of movement of the body with wheels is significantly simplified, that only allows showing how the LVS system works. To do this, the EV body with wheels is represented only by a single-mass mechanical system shown in Fig. 6. The value of the total traction torque of the EV, which is developed by the drives of two driving wheels, including turning, can be expressed by the following equation:

$$T_{\Sigma} = T_r \left(1 + \frac{0,5 d}{R_m} \right) + T_l \left(1 - \frac{0,5 d}{R_m} \right), \quad (28)$$

where $R_m = L / \sin \delta$ is the average value of the turning radius.

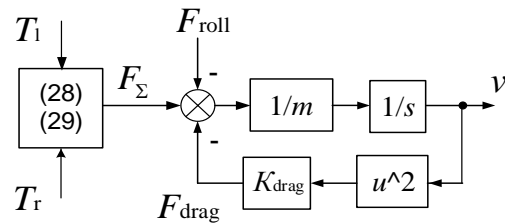

Fig. 6. Functional scheme of a single-mass model of the movement of the EV body with wheels

Source: compiled by the author

At the same time, the EV develops the total traction force

$$F_{\Sigma} = \frac{T_{\Sigma}}{r_w}. \quad (29)$$

There are two resistance forces acting on the EV during its movement – the rolling resistance F_{roll} and the aerodynamic resistance F_{drag} . Then, the equation of balance of forces acting on the EV has the form

$$m \dot{v} = F_{\Sigma} - (F_{roll} + F_{drag}). \quad (30)$$

The forces F_{roll} and F_{drag} are calculated by known expressions

$$F_{roll} = m g k_r; \quad F_{drag} = 0.5 \rho A_f C_d v^2, \quad (31)$$

where: k_r is the coefficient of rolling resistance; ρ is the air density; A_f is the EV frontal area and C_d is the coefficient of aerodynamic drag of the EV body.

According to the functional scheme shown in Fig. 5, the general computer model of movement of the studied EV is constructed in Matlab/Simulink environment.

Table 1. Parameters of the studied EV

Parameter	Value
Equipped weight, m [kg]	1200
Frontal track, d [m]	1.47
Distance from the center of mass to the front axle, a [m]	1.05
Distance from the center of mass to the rear axle, b [m]	1.355
Angular stiffness of the front axle tires when turning, C_f [N/rad]	72150
Angular stiffness of the rear axle tires when turning, C_r [N/rad]	81102
Frontal area, A_f [m ²]	2.05
Aerodynamic drag coefficient of the EV body, C_d	0.3
Tire radius, r_w [m]	0.293
The moment of inertia of the wheel, J_w [kg m ²]	1.8
Rolling resistance coefficient, k_r	0.015

Source: compiled by the author

Parameters of studied EV and its LVS system

Necessary for modeling parameters of the studied EV, which were obtained according to the similar data from the literature, are given in Table 1.

The electric drives of the wheels are realized based on the brushless DC motors, which are commutated by the signals of the built-in Hall sensors. Parameters of permanent magnet motors: number of pole pairs 10, active resistance and inductance of the armature winding 0.15 Ohm and 8 mH respectively, and magnetic flux linkage of the armature winding with one pair of poles of permanent magnets 0.2 Wb. The motors are connected to the wheels via gearboxes with a gear ratio of 2.65.

For listed in Table 1 EV parameters, according to (23), the dependences of the desired yaw-rate γ_d on the EV velocity v for different values of the turn angle of the front wheels δ were obtained and shown in Fig. 7 (for the studied EV, the value of $K = 7.0256 \cdot 10^{-4}$). It also shows the constraint curves $\gamma_{max}(v)$ for a road with different coefficients of coupling (dry and wet) obtained according to (25). The values of the relative coefficient of friction between the wheels and the road surface μ are taken as the maximum for the critical slip in different weather according to [8]. Analysis of the curves in Fig. 7 indicates the need to limit the yaw-rate of the EV even at relatively low speeds. For example, if you turning on 15° at a speed of 25 km/h, the maneuver will be safe on a dry road. However, in wet road, such a maneuver will lead to the EV skidding. To prevent it, it is necessary to operate the

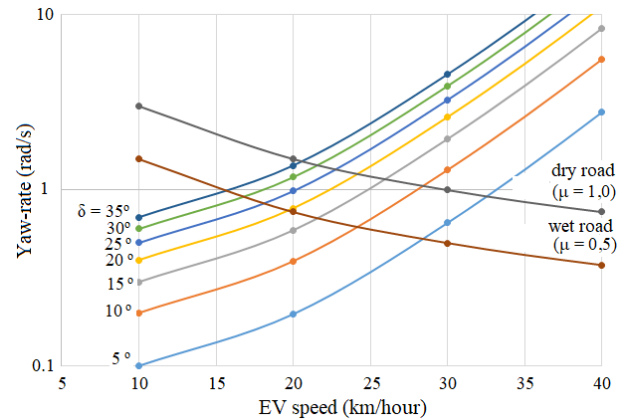

Fig. 7. Dependence of the desired yaw-rate γ_d on the EV speed v and the turn angle δ of the wheels

Source: compiled by the author

LVS system, which by adjusting the torques of the front wheels will generate additional yaw-moment T_z , which will reduce the yaw-rate and thus prevent of the EV skidding.

SIMULATION RESULTS

In the simulation, the studied EV accelerated for 7 s to a speed of 25 km/h and then moved at this constant speed. In the time interval from 15 s to 24 s, the driver set the right turn of the EV wheels at an angle of 20° and, in the time interval from 30 s to 39 s, he set the left turn at the same angle. From the time diagrams in Fig. 8a, it is seen that the developed steering control system clearly fulfilled this task.

According to the dependences calculated for the studied EV and shown in Fig. 7, which characterize its lateral stability, under the specified traffic conditions in the turn, the skidding of the vehicle will be take place, even on dry roads. In order to avoid it, the LVS system generates a task for the additional yaw-moment T_z (Fig. 8b), which, in accordance with (26), is differentially distributed between the torques of the wheel drives to reduce the EV yaw-rate.

Under the action of the additional differential torque, the electromagnetic torques of the drive motors of the right and left wheels in their turns change as can be seen from the obtained time diagrams shown in Fig. 8c.

Correction of wheel torques is such that the outer wheel in turning slightly reduces its propulsion, and the inner one, on the contrary, adds its propulsion, that should reduce the side slip angle to zero and thus stabilize the EV movement. The EV speed set by the driver does not change, which can be seen from the time dependences of the

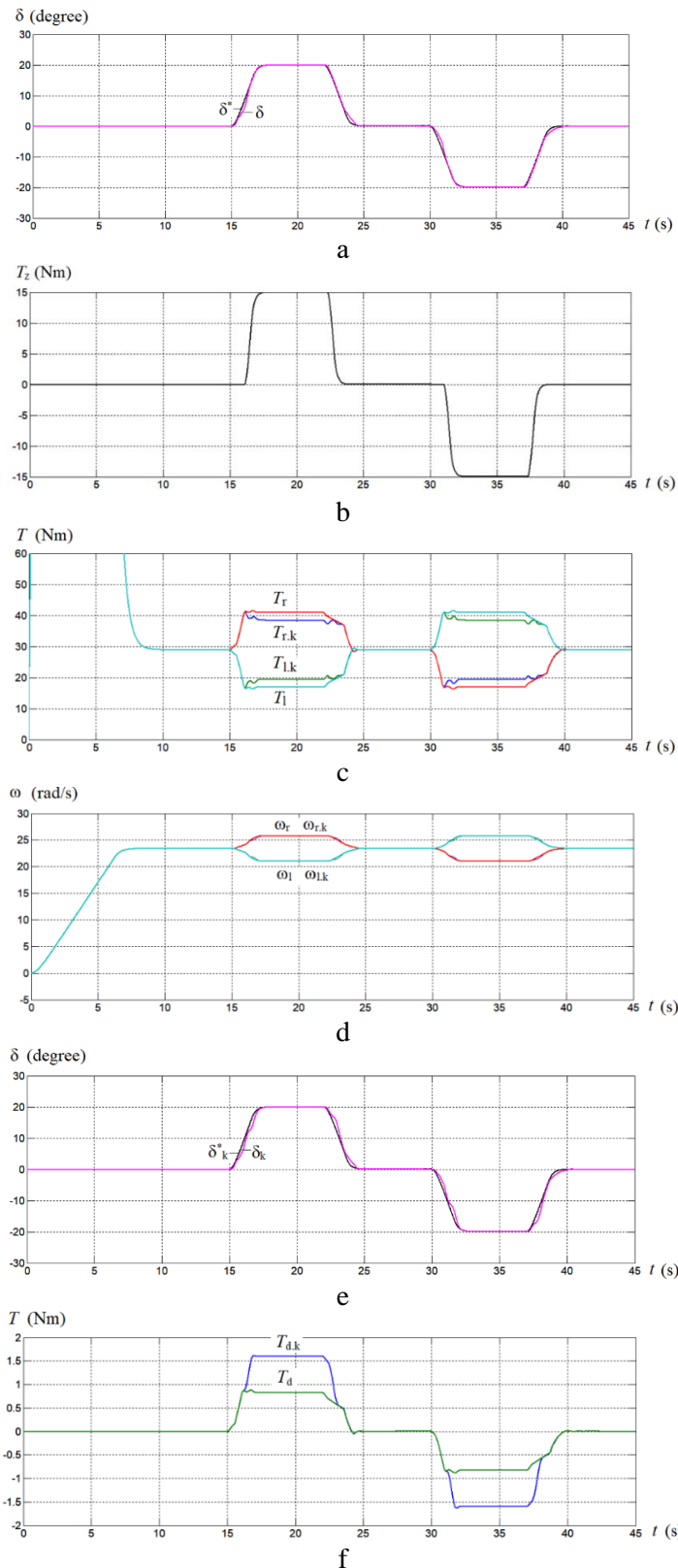

Fig. 8. Results of computer simulation:

a – the front wheels turn angle δ^* set by the driver and its working off by the steering system; b – the task for the additional yaw-moment; c – the electromagnetic torques of the right and left wheel drive motors in turns without and for (index k) inclusion of the LVS system operation; d – the angular velocities of the right and left wheels in turns without and for (index k) inclusion of the LVS system operation; e – the driver-set turn angle of the front wheels δ^*_k and its operation by the steering system during the operation of the LVS system; f – the torque applied by the driver to the steering wheel in turns without and for inclusion (index k) of the LVS system

Source: compiled by the author

angular velocities of the wheels for cases of EV movement in turns without and for (index k) inclusion the LVS system (Fig. 8d). The turn angle set by the driver does not change too (Fig. 8d). Thus, the operation of the LVS system makes actually no changes in the parameters set by the driver of the EV movement and does not pose a threat of an emergency, but, on the contrary, only eliminates the threat of violation of the EV movement stability. However, when the LVS system is turned on, the steering wheel recoil on the driver increases, so he needs to apply more torque to the steering wheel, as can be seen from the time diagrams in Fig. 8e. However, such an impact on the driver has a positive effect – it further draws his attention to the threatening situation.

CONCLUSIONS

The following conclusions can be made from the results of research.

1. Unlike a car, an EV can have more configurations of drivetrain system. In particular, the configuration of front-driving EVs with two independent electric motors that drive their wheels or two in-wheel motors is promising. This configuration greatly simplifies the mechanical transmission of the EV and thus increases its reliability and reduces cost, as well as allows you to put additional functions on the control systems of

the wheel drive motors to improve the controllability and safety of the vehicle.

2. In addition to the gearbox with clutch, the studied EV does not require the mechanical differential too. Its function performs the electronic differential – appropriate control of torques and speeds of the front wheels. The steering system developed earlier and used in this study simultaneously performs the functions of electronic differential, damping of mechanical oscillations in the steering system and strengthening of steering.

3. Detailed elaboration of the regularities of complex nonlinear dynamics of vehicle movement made it possible to outline the option of constructing the LVS system for the studied front-driving EV with independent wheel motors, in which this function relies on high-speed systems of the electromagnetic torques control of the drive motors.

4. The computer simulation of the studied front-wheel driving EV in the Matlab/Simulink environment showed the efficiency of the proposed solutions for the construction of the electronic differential and the LVS control system. However, adequate modeling, simulation of work, as well as visualization of the movement of EV in different situations are possible in the environment of the specialized computer program CarSim.

REFERENCES

1. Yildirim, M., Oksuztepe, E., Tanyeri, B. & Kurum, H. “Electronic differential system for an electric vehicle with in-wheel motor”. *9th Int. Conf. on Electrical and Electronics Engineering (ELECO)*. Turkey: Bursa. 26-28 Nov. 2015. 1048–1052. DOI: <https://doi.org/10.1109/ELECO.2015.7394567>.
2. Chengjie, Z., Guodong, Y. & Nan, C. “The acceleration slip regulation control for two-wheel independent driving electric vehicle based on dynamic torque distribution”. *35th Chinese Control Conf.* Chengdu, China: July 27-29, 2016. 6 p. DOI: <https://doi.org/10.1109/ChiCC.2016.7554286>.
3. Ding, S., Liu, L. & Zheng, W. X. “Sliding model direct yaw-moment control design for in-wheel electric vehicle”. *IEEE Trans. on Industrial Electronics*. 2017; Vol. 64, No. 8: 6752–6762. DOI: <https://doi.org/10.1109/TIE.2017.2682024>.
4. Zhang, H. & Zang, J. “Yaw torque control of electric vehicle stability”. *2012 IEEE 6th Int. Conf. on Information and Automation for Sustainability*. Beijing, China: 27-29 Sept. 2012. 5 p. DOI: <https://doi.org/10.1109/ICIAFS.2012.6419924>.
5. Wu, F. K., Yeh, T. J. & Huang, C. F. “Motor control and torque coordination of an electric vehicle actuated by two in-wheel motors”. *Mechatronics*. 2013; Vol. 23: 46–60. DOI: <https://doi.org/10.1016/j.mechatronics.2012.10.008>.
6. Shchur, I. Z. “Active steering system in the electronic differential of the electric vehicle with individual drive of two front wheels”(in Ukrainian). *Visnyk Natsional'noho Tekhnichnoho Universytetu “KHPI”. Seriya: Problemy Avtomatyzovanoho Elektropryvodu. Teoriya i Praktyka*. 2019; Vol. 16 (1341): 99–104. DOI: <https://doi.org/10.20998/2079-8024.2019.16.18>.

7. Shchur, I., Havdo, I. & Biletskyi, Y. “Modeling of two-motor front-wheel drive control for electric vehicle with electronic differential based on Energetic Macroscopic Representation”. *Energy Engineering and Control Systems*. 2020; Vol.6 No.1: 51–60. DOI: <https://doi.org/10.23939/jeeecs2020.01.051>.
8. Ko, S. Y., Ko, J. W., Lee, S. M., Cheon, J. S. & Kim, H. S. “A study on in-well motor control to improve vehicle stability using human-in-the-loop simulation”. *J. of Power Electronics*. 2013; Vol. 13 No. 4: 536–545. DOI: <https://doi.org/10.6113/JPE.2013.13.4.536>.
9. Li, S., Zhao, D., Zhang, L. & Tian, Y. “Lateral stability control system based on cooperative torque distribution for a four in-wheel motor drive electric vehicle”. *36th Chinese Control Conf.* Dalian, China: July 26-28, 2017. 1119–1123. DOI: <https://doi.org/10.23919/ChiCC.2017.8027497>.
10. Rajamani, R. “Vehicle Dynamics and Control (Mechanical Engineering Series)”. *Springer Science + Business Media*: New York. 2006. 497 p.
11. Shen, C., Yin, G. & Jin, X. “Study on the active steering system with direct yaw-moment control for electric vehicle with electric motored wheels”. *35th Chinese Control Conference*. Chengdu, China: July 27-29, 2016. 8945–8950. DOI: <https://doi.org/10.1109/ChiCC.2016.7554785>.
12. Bayar, K. “Development of a Vehicle Stability Control Strategy for a Hybrid Electric Vehicle Equipped With Axle Motors”. The Ohio State University. 2011. 158 p.
13. Hu, J.-S., Lin, X.-C. & Hu, F.-R. “Direct yaw-moment control for in-wheel motor electric vehicles”. *IEEE/SICE Int. Symp. System Integration*. Tokyo, Japan: 13-15 Dec., 2014. 475–479. DOI: <https://doi.org/10.1109/SII.2014.7028085>.
14. Doumiati, M., Victorino, A. & Charara, A. “Dynamics control of an in-wheel electric vehicle with steer-by-wire”. *2014 IEEE 17th International Conference on Intelligent Transportation Systems (ITSC)*. Qingdao, China: 8-11 Oct., 2014. 348–353. DOI: <https://doi.org/10.1109/ITSC.2014.6957715>.
15. Yuan-kui, S. & Xiao-bin, F. “Research on the application of CarSim in vehicle simulation and development”. *Int. J. of Plant Engineering and Management*. 2017; Vol. 22, No. 4: 200–211. DOI: <https://doi.org/10.13434/j.cnki.1007-4546.2017.0402>.

Conflicts of Interest: the author declare no conflict of interest

Received 26.04.2020

Received after revision 07.06.2020

Accepted 12.06.2020

DOI: <https://doi.org/10.15276/aait.05.2022.3>

УДК 621.33:629.3.027.2

СИСТЕМА КУРСОВОЇ СТАБІЛІЗАЦІЇ РУХУ ЕЛЕКТРОМОБІЛЯ З ДВОМА ПЕРЕДНІМИ ВЕДУЧИМИ КОЛЕСАМИ

Ігор Зенонович Щур

ORCID: <https://orcid.org/0000-0001-7346-1463>; ihor.z.shchur@lpnu.ua. Scopus ID: 36348908300
Національний університет «Львівська політехніка», вул. С. Бандери, 12. Львів, 79013, Україна

АНОТАЦІЯ

Високі питомі показники потужності та моменту сучасних електродвигунів, а також відносна простота реалізації системи електроприводу зумовлюють доцільність застосування в електромобілі (ЕМ) окремих приводів двох і більше коліс. Конфігурація повного ЕМ з двома ведучими передніми колесами, яка розглядається у цій роботі, є ще малопоширеною, проте їй властива перевага щодо кардинального спрощення трансмісії та кермового механізму. Особливістю цієї конфігурації є можливість виконання системами приводів передніх коліс, крім основної функції забезпечення тяги і гальмування на нижньому рівні керування, ще цілої низки додаткових функцій вищого рівня. У доповнення до вже раніше розроблених нами функцій електронного диференціала, електричного підсилення керма та демпфування пружних коливань кермового механізму, у даній роботі додається також функція курсової стабілізації руху в поворотах електромобіля. У статті

розглянута математична модель з сімома ступенями вільності, що описує динаміку руху чотириколісного транспортного засобу, та показано, як ця модель може бути спрощена до двоступеневої моделі, що описує динаміку руху двоколісного транспортного засобу. Цієї моделі достатньо для оцінки стійкості руху електромобілі в поворотах та формування завдання на додатковий момент, який би регулював кутову швидкість нищпорення кузова для запобігання заносу електромобілів в поворотах. На цій основі розроблено структуру системи курсової стабілізації руху, яка коректує електромагнітні моменти привідних двигунів передніх коліс для формування потрібного моменту нищпорення. Для дослідного ЕМ із заданими параметрами розраховані залежності допустимої кутової швидкості нищпорення за заданих водієм швидкості руху і кута повороту коліс електромобілів в різних умовах зчеплення коліс із дорожнім полотном. Розроблено загальну функціональну модель передньопривідного дводвигунного електромобілів із дворівневою системою керування, яка виконує усі вищесказані функції. У середовищі Matlab/Simulink побудована комп'ютерна математична модель цього електромобілю та проведено симуляційні дослідження, які демонструють роботу системи курсової стабілізації руху електромобілі в поворотах.

Ключові слова: електромобіль; індивідуальний привід двох передніх коліс; мотор-колесо; безщітковий двигун постійного струму; електронний диференціал; система курсової стабілізації руху

ABOUT THE AUTHOR



Ihor Zenonovich Shchur - D. Sc. (Eng), Professor, Head of Department of the Electromechatronics and Computerized Electromechanical Systems, Lviv Polytechnic National University, 12, S. Bandery Str. Lviv, 79013, Ukraine

ORCID: <https://orcid.org/0000-0001-7346-1463>; ihor.z.shchur@lpnu.ua. Scopus Author ID: 36348908300

Research field: Control systems of vehicle electric drive; renewable energy; energy storage systems; energy-based mathematical modeling and synthesis of control systems

Ігор Зенонович Щур - доктор технічних наук, професор, зав. каф. Електромехатроніки і комп'ютеризованих електромеханічних систем Національного університету «Львівська політехніка», вул. С. Бандери, 12. Львів, 73013, Україна